

REV NO.	Revision Note	Date	Signature	Checked

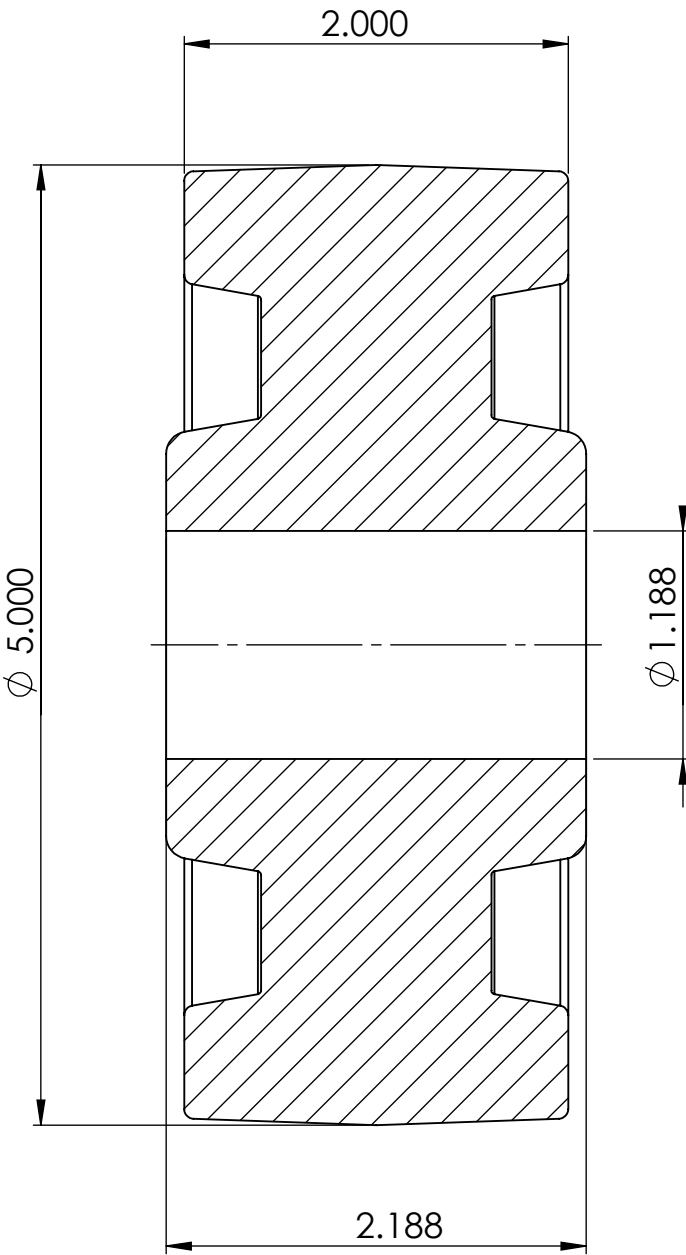
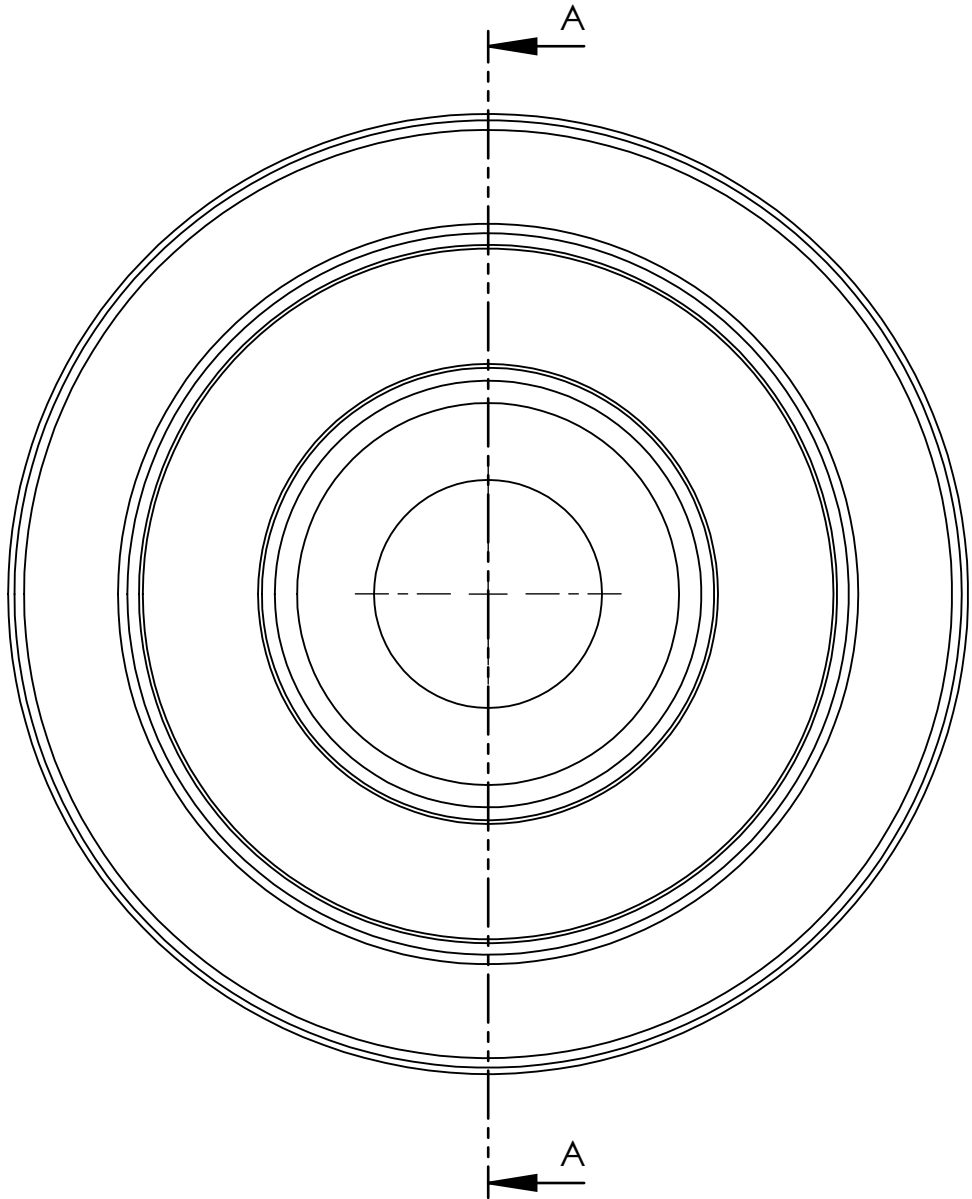
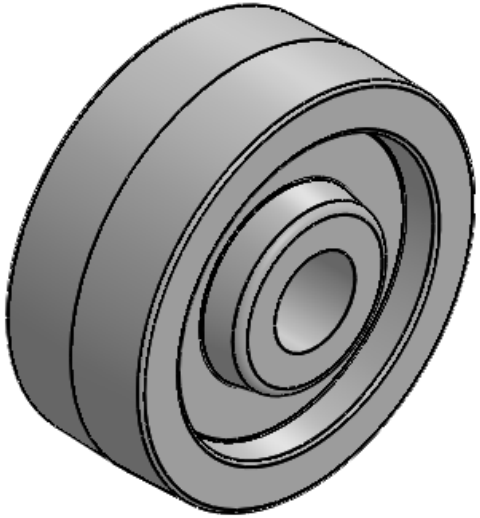

SECTION A-A  
SCALE 1 : 1

<b>P&amp;H Casters</b>	Scale 1:1	Volume (mm <sup>3</sup> )	Drawn By: Ashley	Date 1/24/20
Description 5" x 2" White Polypropylene		P&H Approval		
Part Number 52-11XL-W	Revision REV A	Sheet 01	Date	