

REV NO.	Revision Note	Date	Signature	Checked

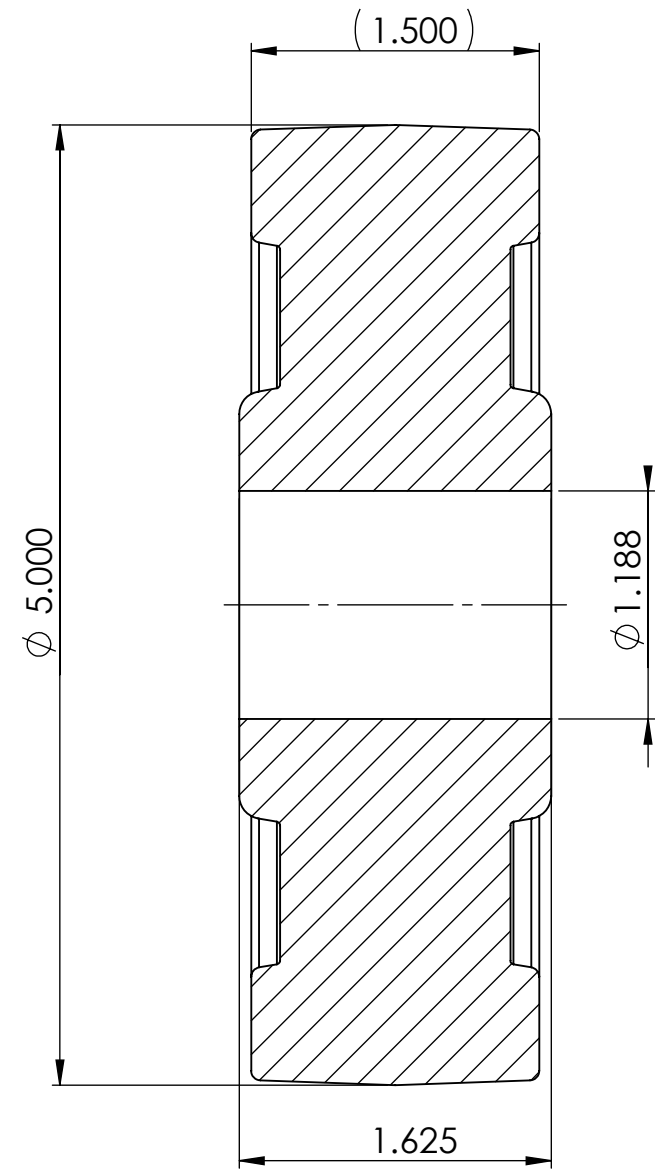
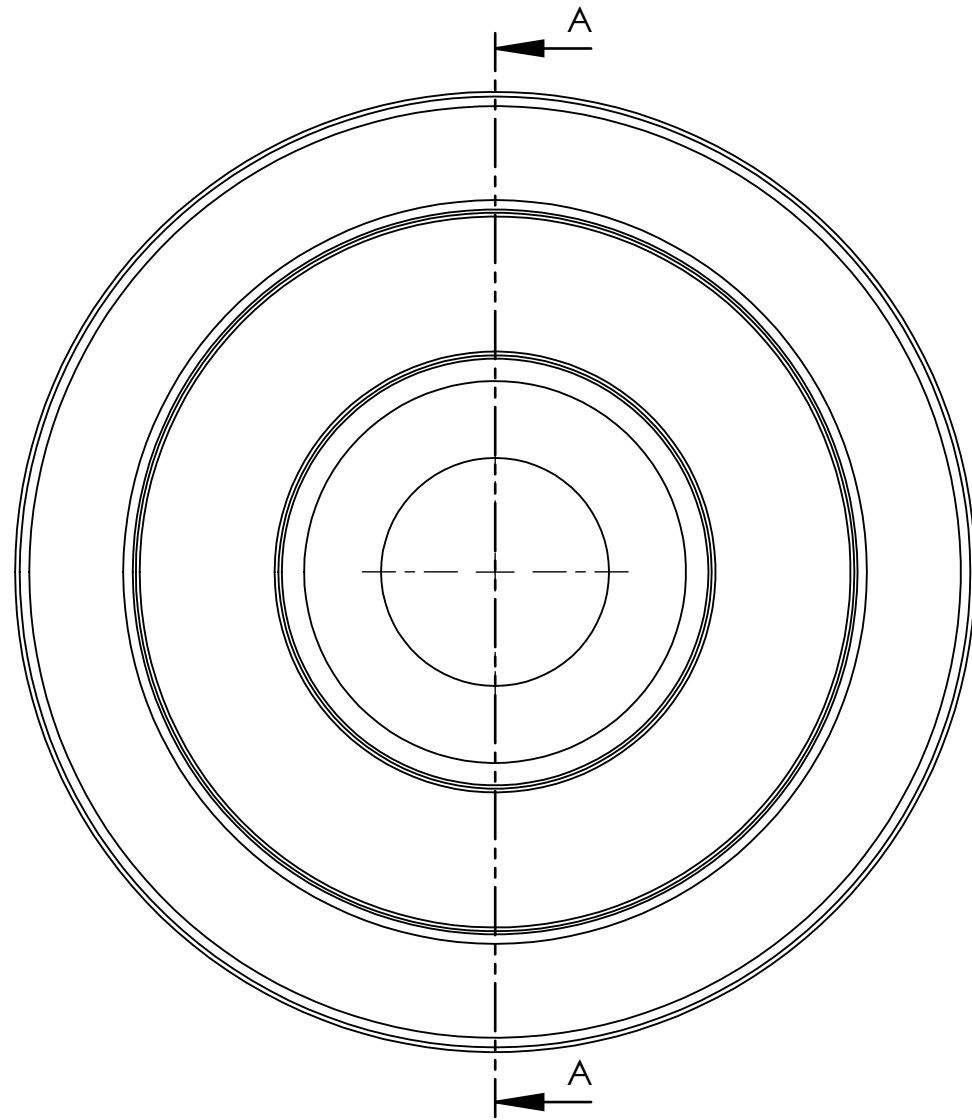
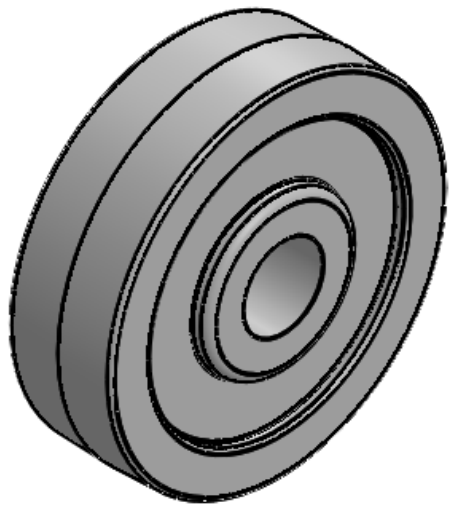

SECTION A-A
SCALE 1 : 1

P&H Casters	Scale 1:1	Volume (mm ³)	Drawn By: Ashley	Date 1/23/20
Description 5" X 1 1/2" White Polypropylene		P&H Approval		
Part Number 55-11XL-W	Revision REV A	Sheet 01	Date	 FIRST ANGLE PROJECTION