

Durometer: Shore D 46 (+/-5)

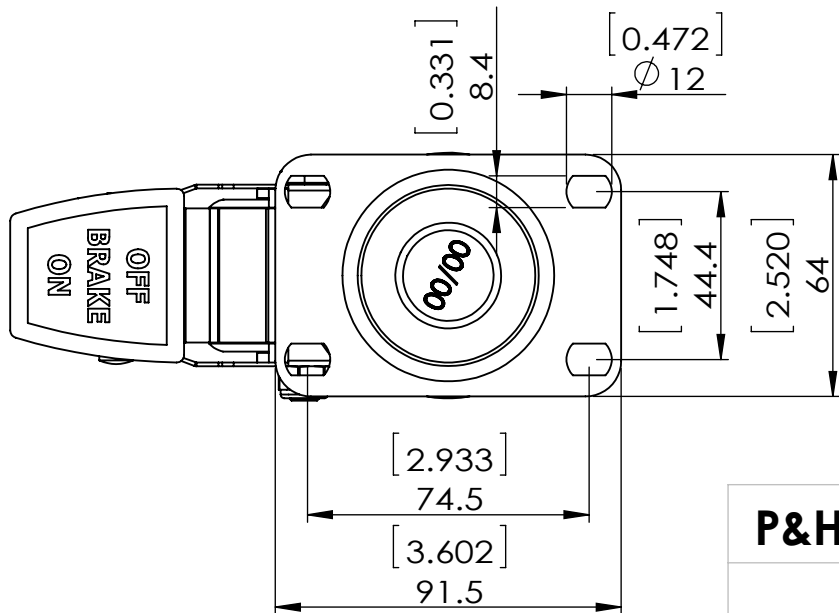

Dimensions in mm [inch]

P&H Casters		Scale	1:2	Volume (mm ³)	Drawn By:	Date
Description		CASTER		Reviewed	Hua	2020/3/25
Part Number	Revision	Sheet	01	Date	Andy	 FIRST ANGLE PROJECTION
Z26P154CLDET	REV A			2020/3/25		