

REV NO.	Revision Note	Signature	Date	Checked	Date

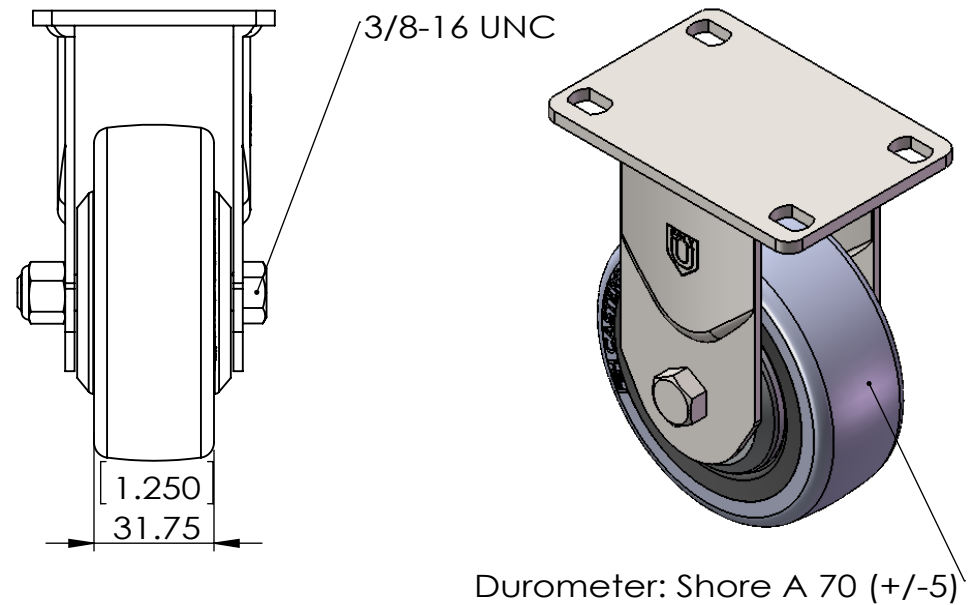
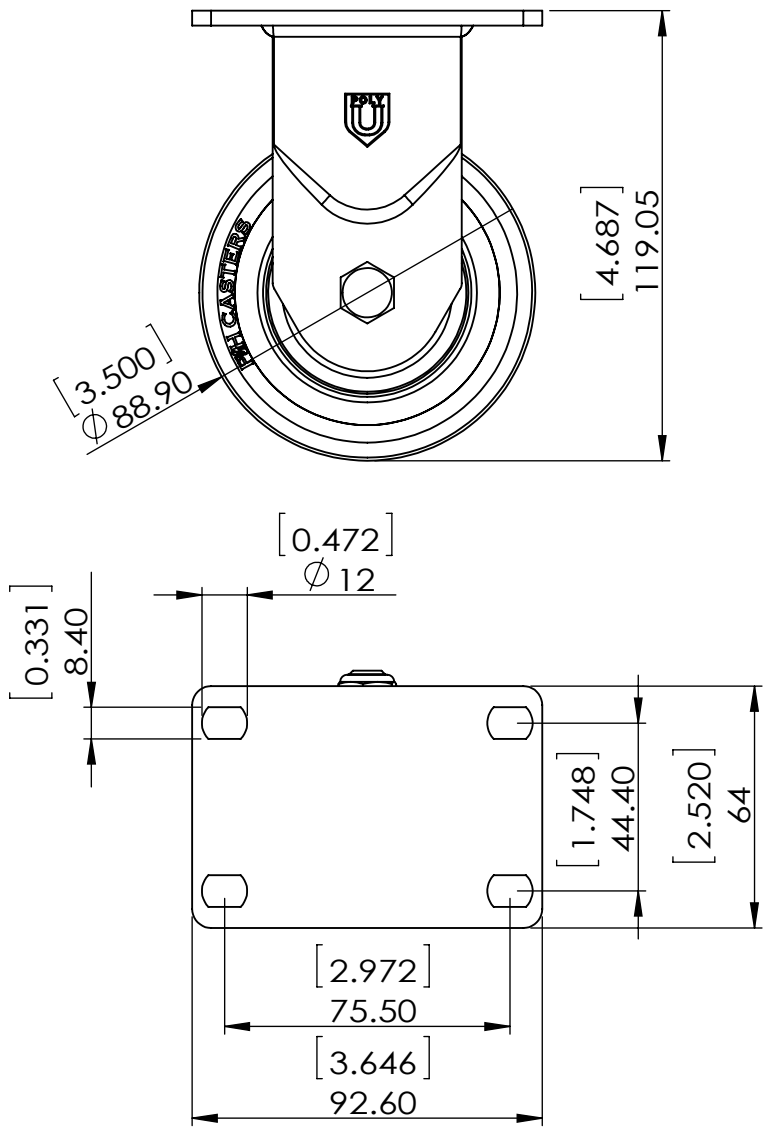

Dimensions in mm [inch]

P&H Casters		Scale 1:2	Volume (mm ^ 3)	Drawn By: Hua	Date 2019/4/10
Description CASTER				Reviewed Andy	
Part Number Z27P174NEKI REV A	Revision	Sheet 01	Date 2019/4/10		