

REV NO.	Revision Note	Date	Signature	Checked

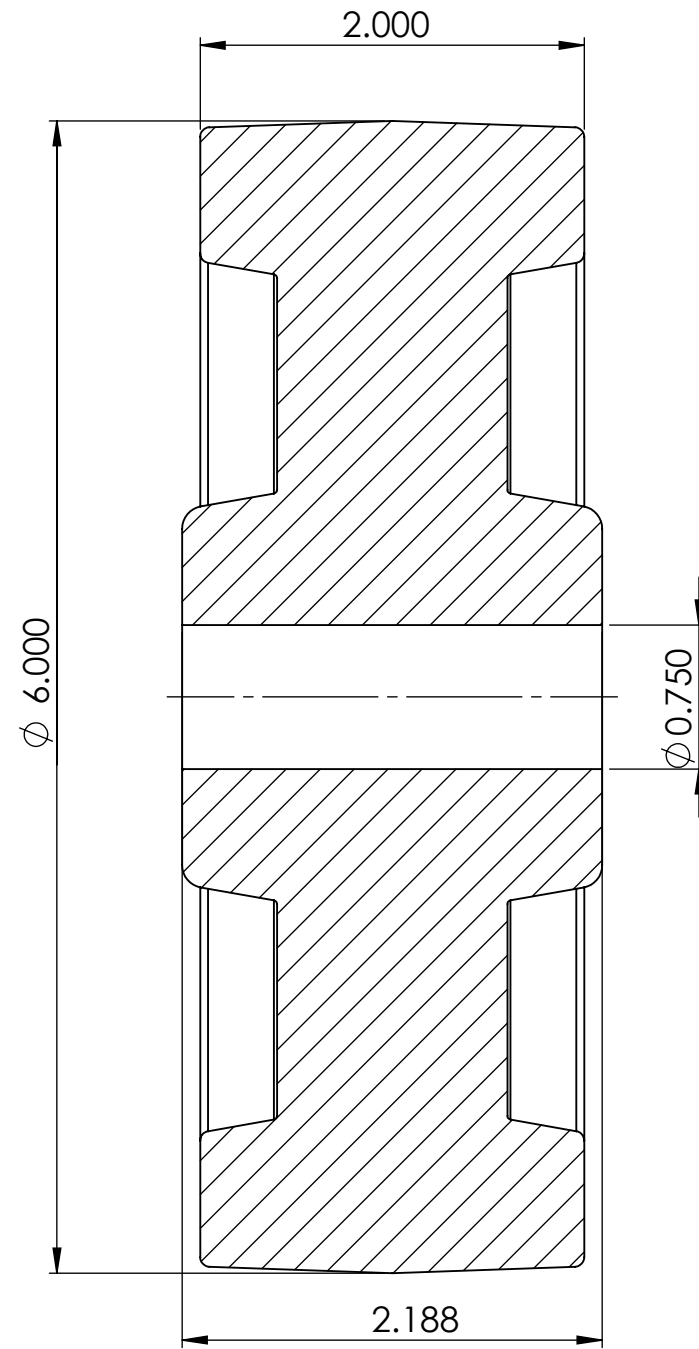
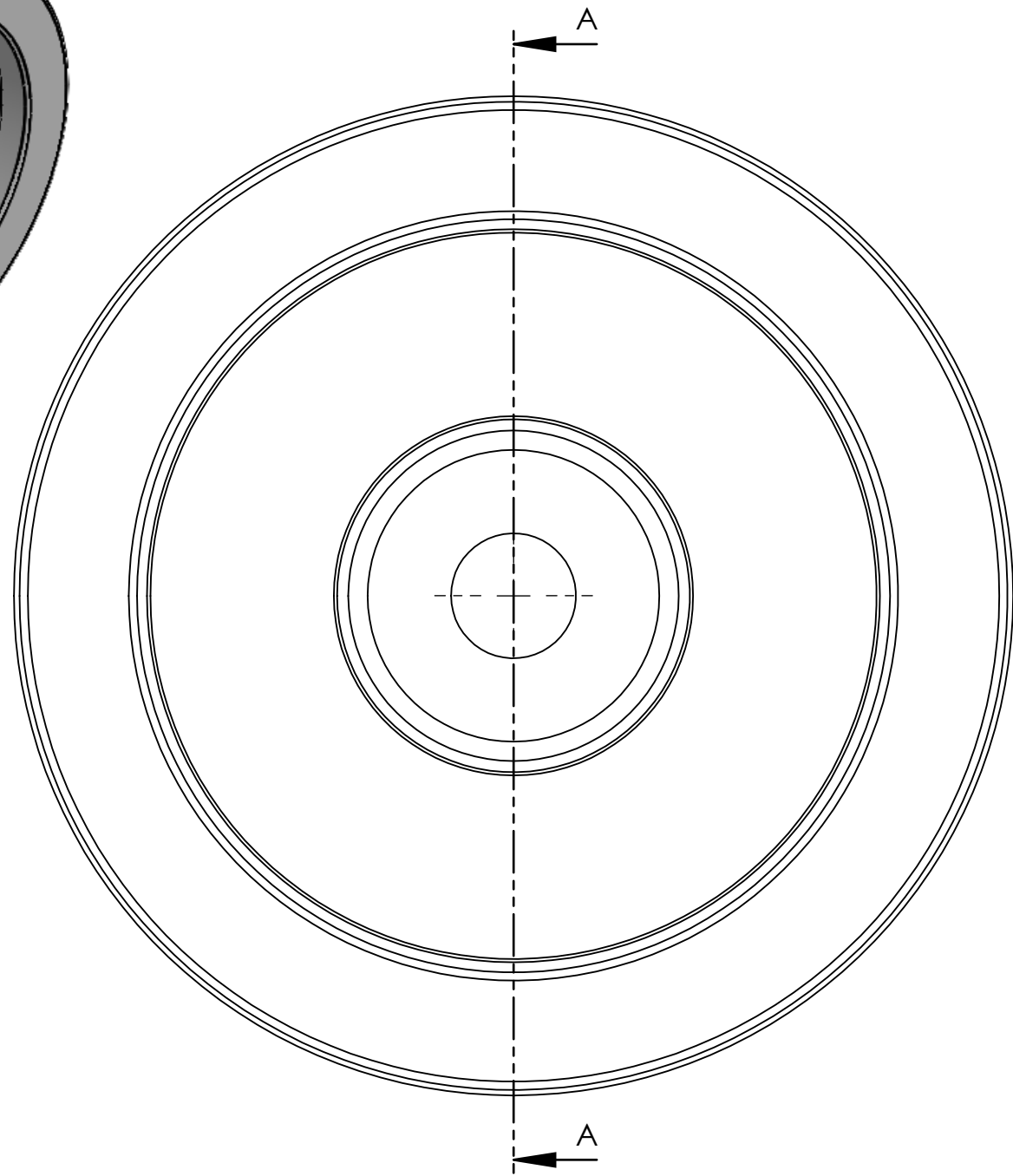
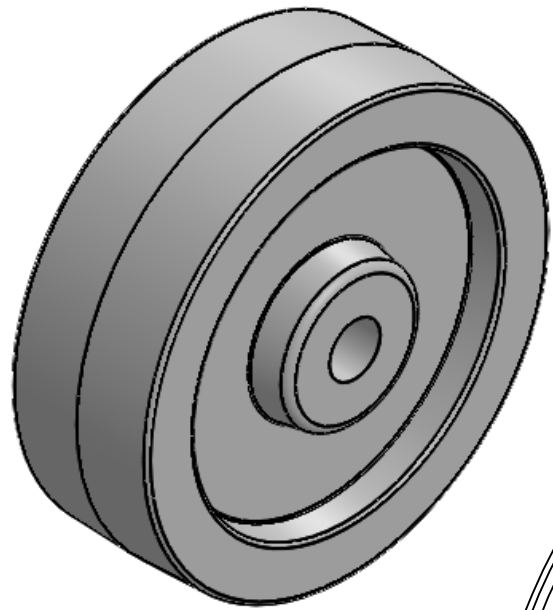

SECTION A-A
SCALE 1 : 1

P&H Casters	Scale 1:1	Volume (mm ³)	Drawn By: Ashley	Date 1/24/20
Description 6" x 2" White Polypropylene		P&H Approval		
Part Number 62-11E-W	Revision REV A	Sheet 01	Date	