

REV NO.	Revision Note	Date	Signature	Checked

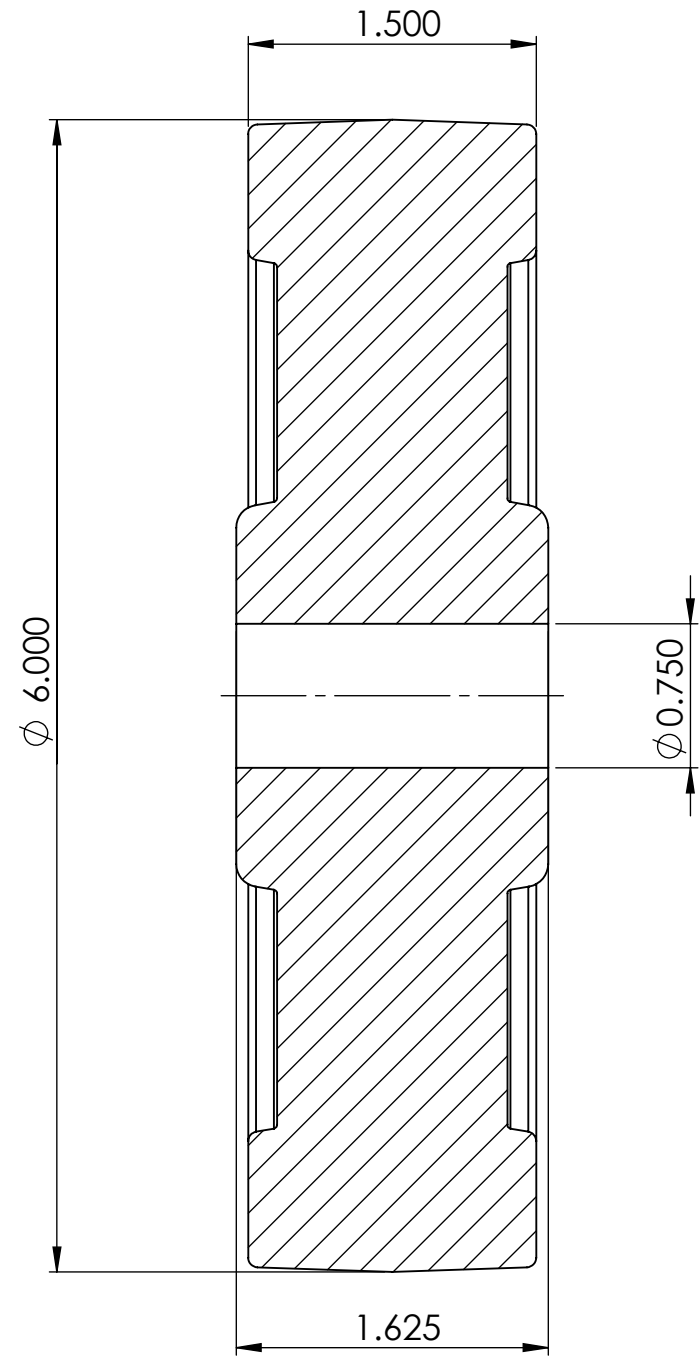
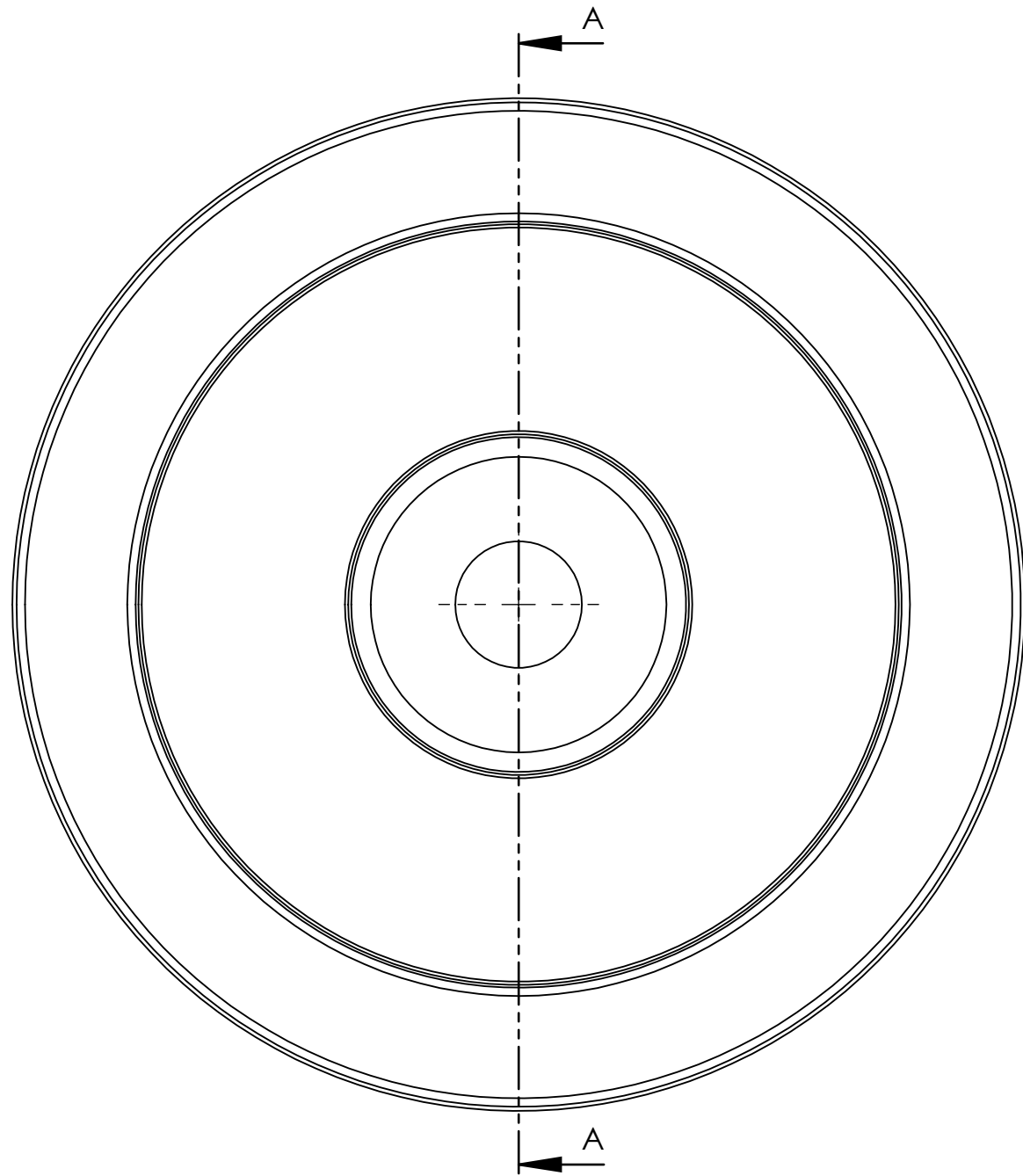
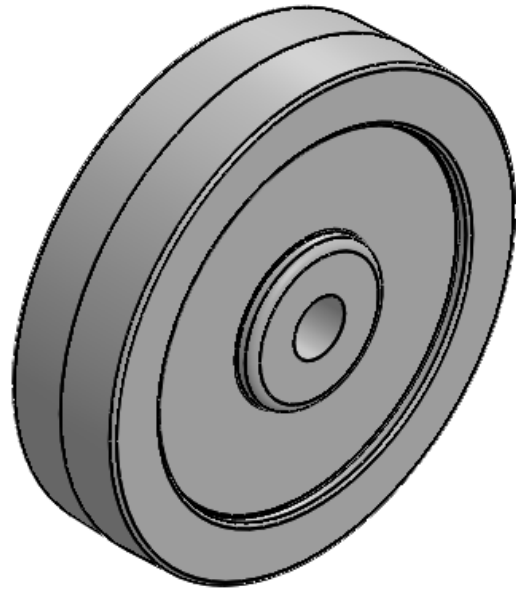

SECTION A-A  
SCALE 1 : 1

<b>P&amp;H Casters</b>	Scale 1:1	Volume (mm <sup>3</sup> )	Drawn By: Ashley	Date 1/30/20
Description	6" X 1 1/2" White Retort		P&H Approval	
Part Number 65-121E-W	Revision REV A	Sheet 01	Date	