

REV NO.	Revision Note	Date	Signature	Checked

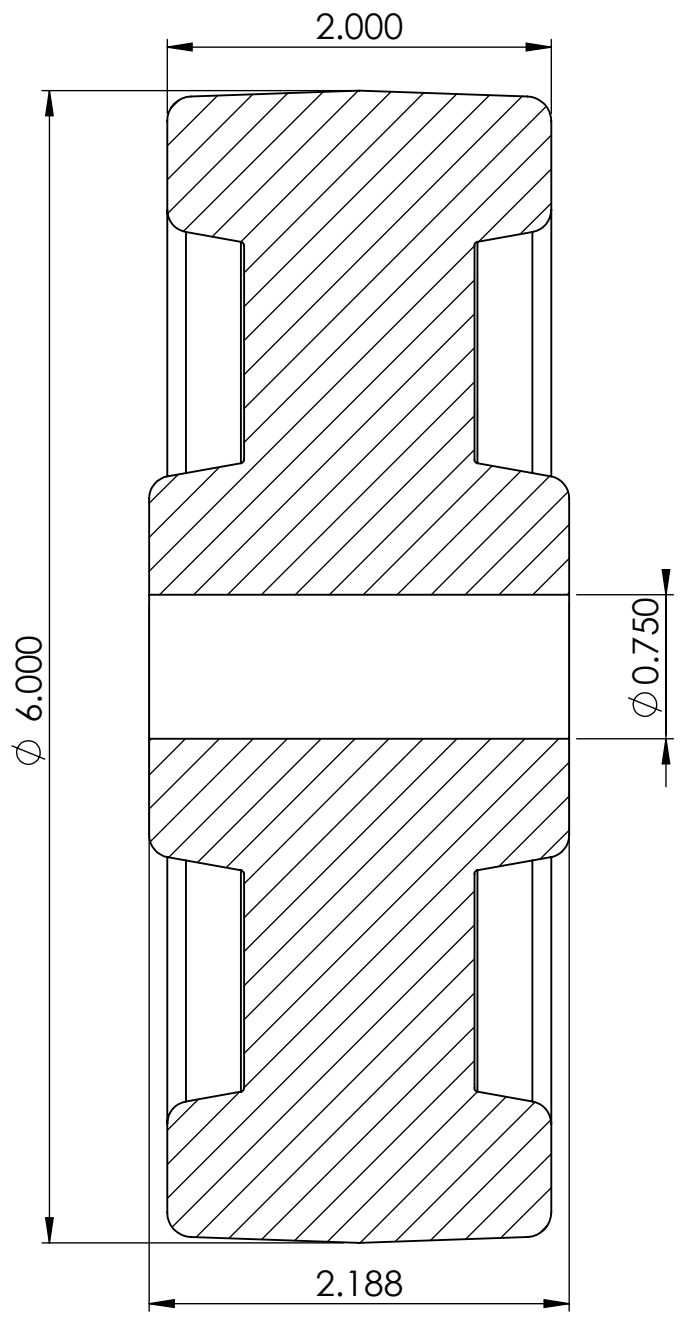
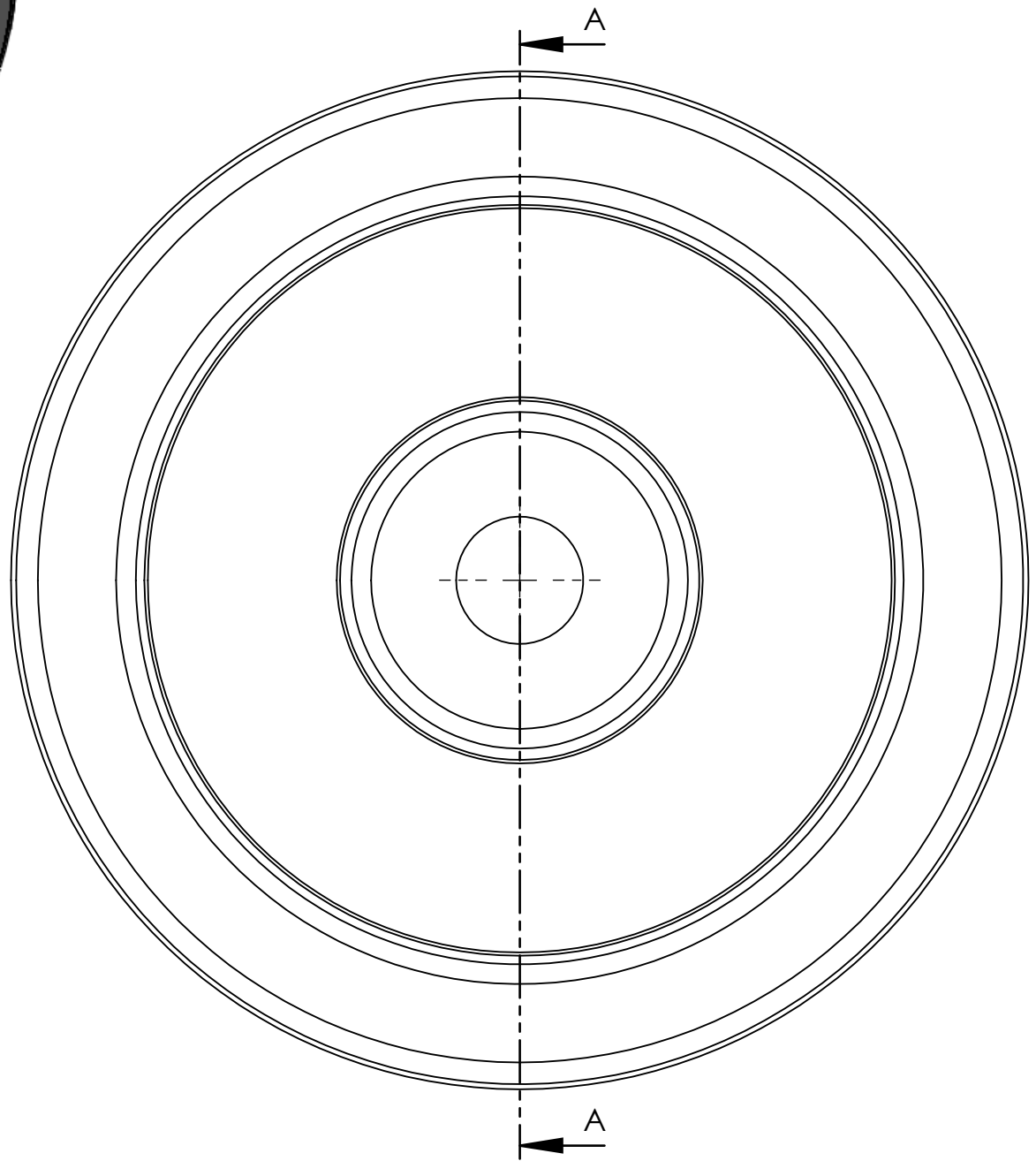

SECTION A-A  
SCALE 1 : 1

<b>P&amp;H Casters</b>	Scale 1:1	Volume (mm <sup>3</sup> )	Drawn By: <b>Ashley</b>	Date 1/22/20
Description 6" X 2" Black HeatEater			P&H Approval	
Part Number 62-171E-B	Revision Rev A	Sheet 01	Date	